

## Hairpin Heat Exchangers

*Serving the petroleum, petrochemical, chemical and power industries.*

Bulletin 10

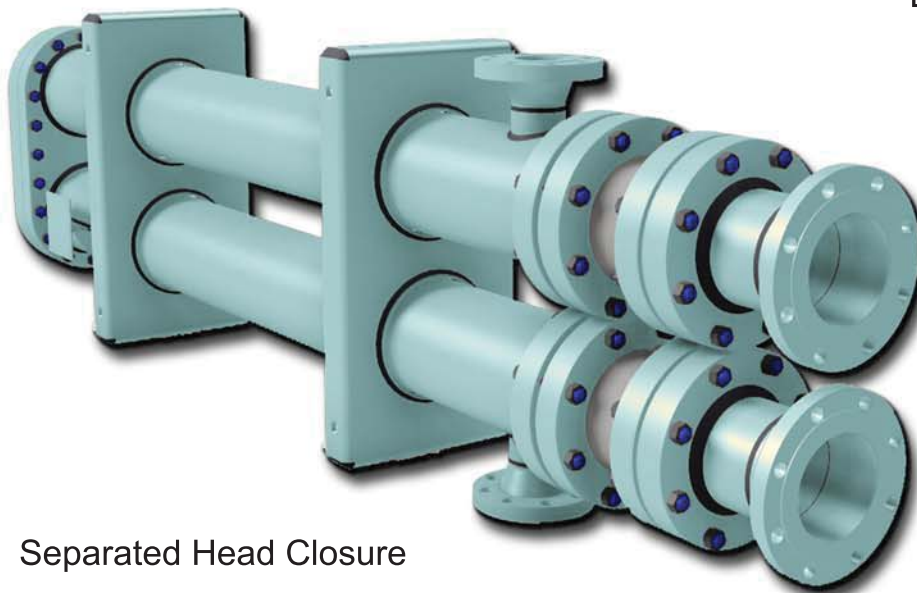

Separated Head Closure

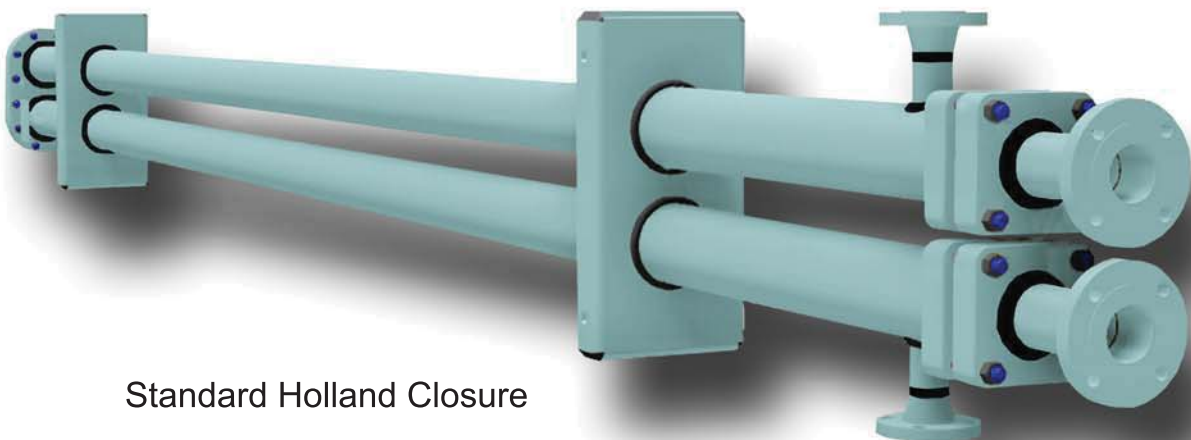

Standard Holland Closure

## PETROFIN<sup>®</sup> Patented Closure

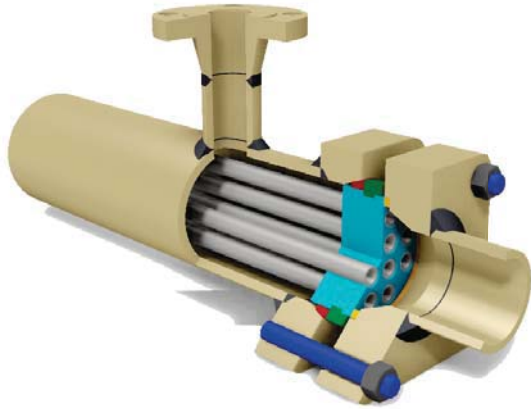

### THE HOLLAND PETROFIN CLOSURE

1. The Holland Petrofin closure has fewer parts, is the simplest to install and disassemble, and is the most efficient seal on the market. Only two flanges are needed to secure both shell and tube seals. No other manufacturer does this with comparable results.
2. With one expendable seal for the shell side and one expendable seal for the tube side, there is an absolute guarantee against interstream leakage.
3. There is only one reusable locking split ring which is in full view and is the simplest of all to remove and install.
4. Closure flanges on low pressure units up to 6" shell size area a square, 4 bolt design. Larger units and high pressure smaller units have circular closure flanges with additional bolting. Through-bolted closures are not standard on 6" and smaller units, but are available upon request.
5. Tube bundles are easily removed and do not require disassembly of either the shell piping or mountings. Only five standard interchangeable replacement parts are required for reassembly after routine cleaning and maintenance. These are the rear cover gasket, sealing rings, and tube gaskets. Most sizes are stocked for immediate replacement.
6. Our unique closure allows for more tubes in a given shell size resulting in more heat exchange for the same competitive price.

### THE HOLLAND HAIRPIN HEAT EXCHANGER

1. All Holland hairpin heat exchangers are ASME inspected, code stamped and National board registered.
2. Multiple sections can be shipped completely assembled and ready for one inlet and outlet process piping connection.
3. Our longitudinal fintubes are produced by an electric resistance welding method, which assures high heat transfer efficiency throughout the life of the equipment.
4. Holland hairpin heat exchangers are available in a wide range of sizes to meet most process requirements. See pages 4 and 5 for the many standard design double pipe and multi-tube hairpin exchangers which are available.
5. R.W. Holland's standard designs reduce costs of engineering, thermal design, drafting, and shop fabrication. Although we offer standardized designs whenever possible, we custom engineer equipment to meet process or piping requirements. A few of our customers modifications are shown in this brochure.

## Separated Head Closure

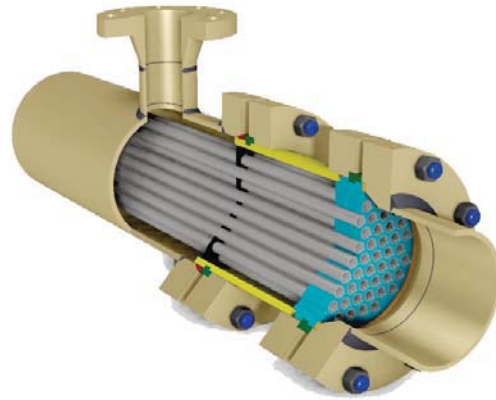

### THE HOLLAND SEPARATED HEAD CLOSURE

1. The Holland Separated Head Closure has separate flanges and bolting for each sealing surface.
2. With one expendable seal for the shell side, one expendable seal for the tube side, separate flanged and bolted joints for each sealing surface, this closure can handle all applications in severe service.
3. This closure is recommended for pressures above 2000 psig, cyclic services, low temperature service, extreme temperature differentials and hard to hold fluids.
4. Tube bundles are easily removed and do not require disassembly of either the shell piping or mountings. Only five standard interchangeable replacement parts are required for reassembly after routine cleaning and maintenance. These are the rear cover gasket, sealing rings and tube gaskets. Most sizes are stocked for immediate replacement.

### ADVANTAGES OF THE HAIRPIN HEAT EXCHANGER

1. There are two types of hairpin heat exchangers.
  - a. Double pipe section with one tube, either finned or bare, within the shell pipe.
  - b. Multi-tube section with smaller tubes, either finned or bare, within the shell pipe.
2. Hairpin heat exchangers operate in true counter current flow permitting extreme temperature crossing. The full log mean temperature difference can be utilized without reducing correction factors generally necessary in shell and tube exchangers. The larger temperature difference decreases surface requirements and cost.
3. Due to their modular concept, hairpin heat exchangers are economically adaptable to service changes. Changing duties are met by merely rearranging, adding, or subtracting sections. Shell and tube exchangers frequently have to be scrapped and new exchangers ordered when duties change.
4. The hairpin exchanger is ideal for wide temperature ranges and differentials. Because of the U-tube construction, expensive expansion joints are not required. Hairpin heat exchangers are not susceptible to tube-to-tubesheet weld cracks due to thermal stress. The thermal gradient of a tubesheet on a hairpin heat exchanger is through the thickness of the tubesheet as apposed to across the tubesheet face, as in multi-pass shell & tube exchangers.
5. Hairpin deliveries are shorter than shell and tube due to the standardization of design and construction.

# R. W. HOLLAND, INC. - PETROFIN<sup>®</sup>

## HAIRPIN MODEL IDENTIFICATION CODE

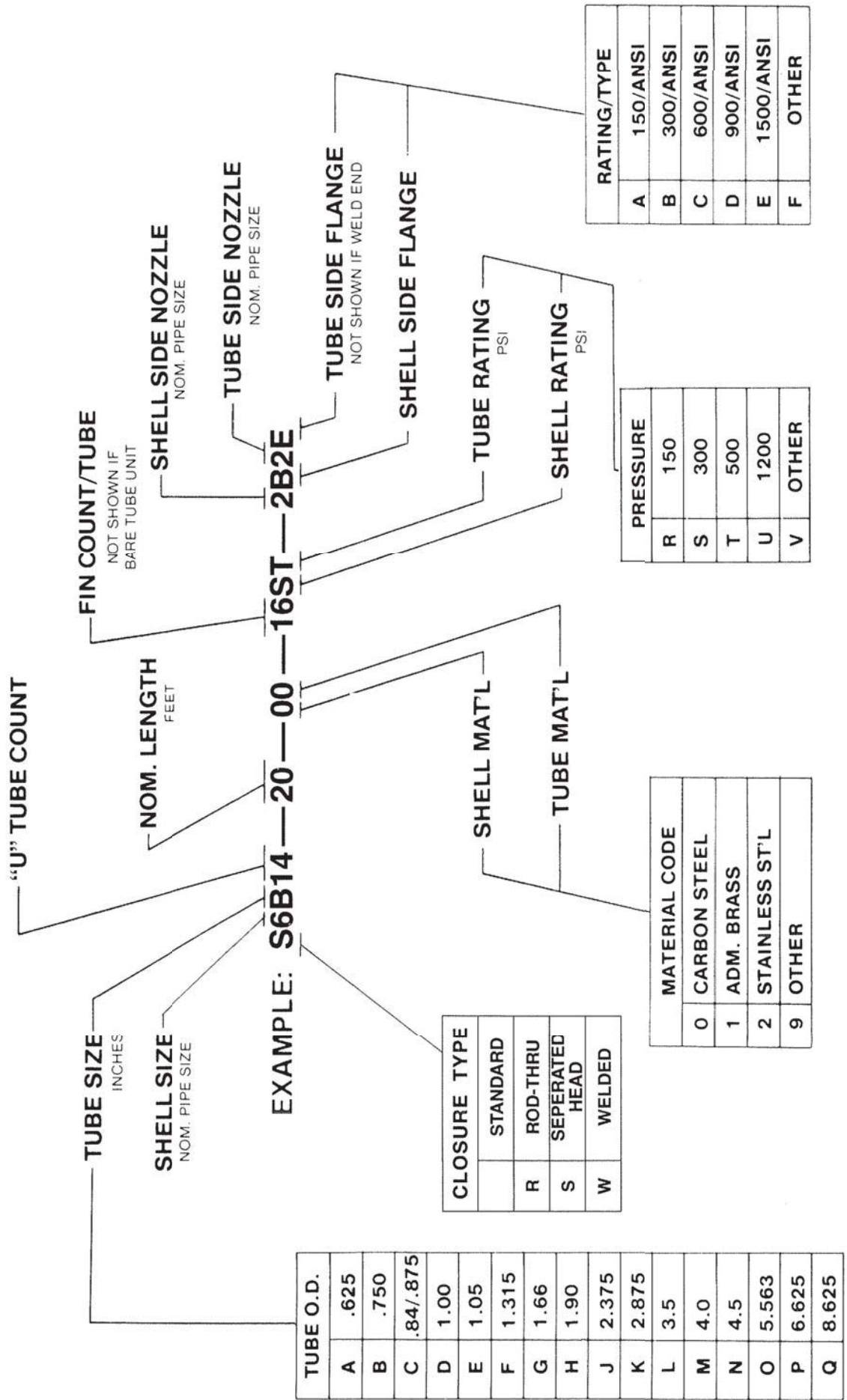

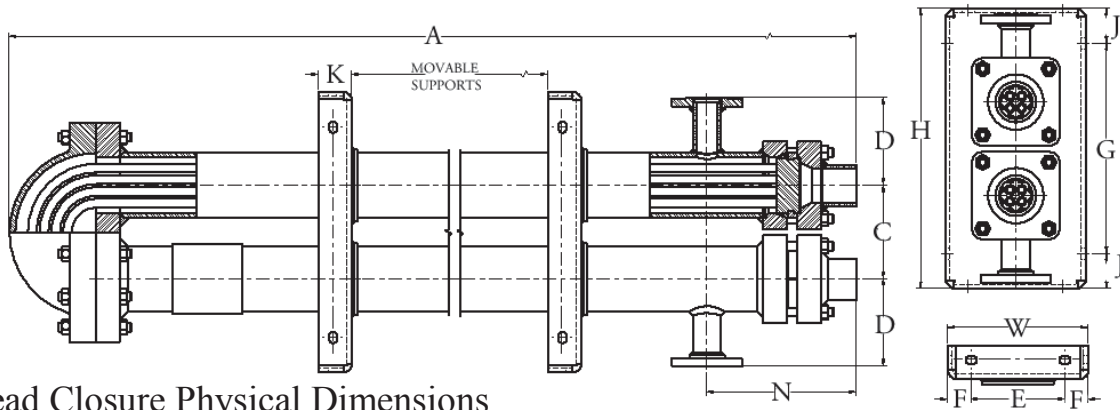

Standard Head Closure Physical Dimensions

Shell Size	Overall Length Nom +A	Nozzle N	Width W	Height H	Center C	Nozzle D	Moveable Brackets					Shell Nozzle Size	Tube Nozzle
							E	F	G	J	K		
1 1/2"	NOM + 12 3/4"	11 1/2"	8"	13 1/2"	4 1/2"	4 1/2"	5"	1 1/2"	9 1/2"	2"	2 3/4"	3/4"-150#	3/4"W.E
2"	NOM + 12 3/4"	11 1/2"	8"	13 1/2"	4 1/2"	4 1/2"	5"	1 1/2"	9 1/2"	2"	2 3/4"	1"-150#	1"W.E
2 1/2"	NOM + 12 3/4"	11 1/2"	8"	13 1/2"	4 1/2"	4 1/2"	5"	1 1/2"	9 1/2"	2"	2 3/4"	1 1/2"-150#	1 1/2"W.E
3"	NOM + 12 3/4"	11 3/4"	8"	13 1/2"	4 1/2"	4 1/2"	5"	1 1/2"	9 1/2"	2"	2 3/4"	2"-150#	2"W.E
3 1/2"	NOM + 13 5/16"	13"	10"	16"	6"	5"	7"	1 1/2"	10"	3"	2 3/4"	2"-150	2"W.E
4"	NOM + 13 5/16"	13"	10"	16"	6"	5"	7"	1 1/2"	10"	3"	2 3/4"	3"-150#	3"W.E
5"	NOM + 16 1/2"	13 3/4"	12"	24"	8"	8"	8"	2"	18"	3"	2 7/8"	3"-150#	3"W.E
6"	NOM + 16 1/2"	13 3/4"	12"	24"	8"	8"	8"	2"	18"	3"	2 7/8"	4"-150#	4"W.E
8"	NOM + 19 5/8"	14 3/4"	15"	30"	12"	9"	9"	3"	24"	3"	2 7/8"	6"-150#	6"W.E
10"	NOM + 23 1/4"	16 1/2"	18"	35"	15"	10"	12	3"	27"	4"	5"	As Req.	As Req.
12"	NOM + 25 3/4"	18"	20"	40"	18"	11"	14	3"	32"	4"	5"	As Req.	As Req.
14"	NOM + 26"	20"	24"	48"	24"	12"	19	3"	38"	5"	5"	As Req.	As Req.
16"	NOM + 26"	20"	24"	48"	24"	12"	19	3"	38"	5"	5"	As Req.	As Req.

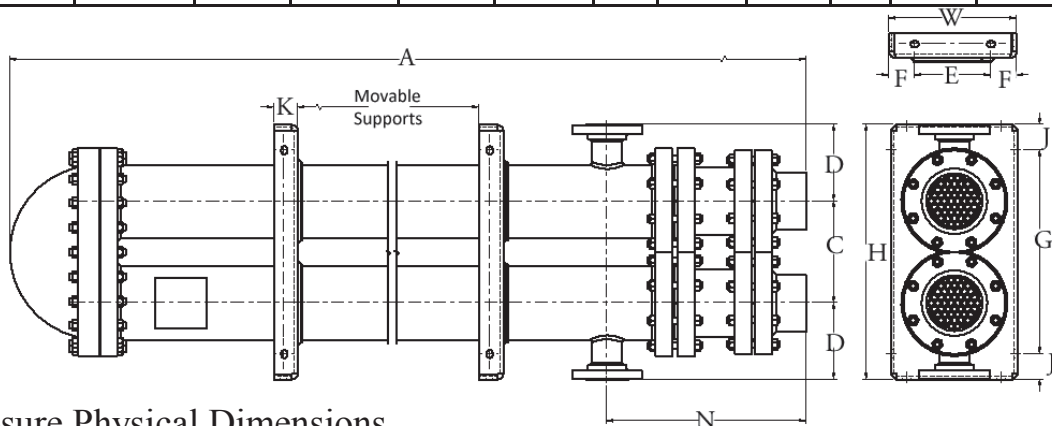

Separated Closure Physical Dimensions

Shell Size	Overall Length Nom +A	Nozzle N	Width W	Height H	Center C	Nozzle D	Moveable Brackets					Shell Nozzle Size	Tube Nozzle
							E	F	G	J	K		
1 1/2"	NOM + 19 1/8"	17 7/8"	8"	13 1/2"	4 1/2"	4 1/2"	5"	1 1/2"	9 1/2"	2"	2 3/4"	3/4"-150#	3/4"W.E
2"	NOM + 19 1/8"	17 7/8"	8"	13 1/2"	4 1/2"	4 1/2"	5"	1 1/2"	9 1/2"	2"	2 3/4"	1"-150#	1"W.E
2 1/2"	NOM + 19 1/8"	17 7/8"	8"	13 1/2"	4 1/2"	4	5"	1 1/2"	9 1/2"	2"	2 3/4"	1 1/2"-150#	1 1/2"W.E
3"	NOM + 19 1/8"	18 1/8"	8"	13 1/2"	4 1/2"	4 1/2"	5"	1 1/2"	9 1/2"	2"	2 3/4"	2"-150#	2"W.E
3 1/2"	NOM + 19	19 3/8"	10"	16"	6"	5"	7"	1 1/2"	10"	3"	2 3/4"	2"-150	2"W.E
4"	NOM + 19	19 3/8"	10"	16"	6"	5"	7"	1 1/2"	10"	3"	2 3/4"	3"-150#	3"W.E
5"	NOM + 25	22 3/16"	12"	24"	8"	8"	8"	2"	18"	3"	2 7/8"	3"-150#	3"W.E
6"	NOM + 25	22 3/16"	12"	24"	8"	8"	8"	2"	18"	3"	2 7/8"	4"-150#	4"W.E
8"	NOM + 28 1/4"	23 3/8"	15"	30"	12"	9"	9"	3"	24"	3"	2 7/8"	6"-150#	6"W.E
10"	NOM + 32 3/4"	26"	18"	35"	15"	10"	12	3"	27"	4"	5"	As Req.	As Req.
12"	NOM + 34 3/4"	27"	20"	40"	18"	11"	14	3"	32"	4"	5"	As Req.	As Req.
14"	NOM + 38 7/16"	32 7/16"	24"	48"	24"	12"	19	3"	38"	5"	5"	As Req.	As Req.
16"	NOM + 38 7/16"	32 7/16"	24"	48"	24"	12"	19	3"	38"	5"	5"	As Req.	As Req.

# Double Pipe Hairpin Sections

## Bare Tube Specific Data

MODEL	TUBE O.D Inches	NO. U-Tubes	SURFACE FT <sup>2</sup>	WEIGHT LBS.	FT <sup>2</sup> SURFACE PER FOOT
1.5A1-20-00-SS-¾A¾	5/8	1	6.69	321	0.33
1.5D1-20-00-SS-¾A¾	1	1	10.66	344	0.52
2B1-20-00-SS-1A¾	0.75	1	8.0	305	0.39
2C1-20-00-SS-1A¾	0.84/.875	1	9.01	310	0.45
2D1-20-00-SS-1A¾	1	1	10.66	314	0.52
2E1-20-00-SS-1A1	1.05	1	11.21	335	0.55
2F1-20-00-SS-1A1	1.315	1	13.8	346	0.69
2G1-20-00-SS-1A1	1.66	1	17.4	360	0.87
2.5D1-20-00-SS-1½A¾	1.0	1	10.66	426	0.52
2.5F1-20-00-SS-1½A1	1.315	1	13.8	435	0.69
2.5G1-20-00-SS-1½A1	1.66	1	17.4	461	0.87
2.5H1-20-00-SS-1½A1½	1.9	1	20.0	481	1.00
3F1-20-00-SS-2A1	1.315	1	13.8	509	0.69
3G1-20-00-SS-2A1	1.66	1	17.4	534	0.87
3H1-20-00-SS-2A1½	1.9	1	20.0	553	1.00
3J1-20-00-SS-2A2	2.37	1	24.9	595	1.24
3.5H1-20-00-SS-2A1½	1.9	1	20.0	743	1.00
3.5J1-20-00-SS-2A2	2.375	1	24.9	783	1.24
3.5K1-20-00-SS-2A2½	2.875	1	30.0	874	1.51
4H1-20-00-SS-3A¾	1.9	1	20.0	813	1.00
4J1-20-00-SS-3A2	2.375	1	24.9	853	1.24
4K1-20-00-SS-3A2½	2.875	1	30.0	944	1.51
4L1-20-00-SS-3A3	3.5	1	36.7	1020	1.83
5K1-20-00-SS-3A2½	2.875	1	30.0	1285	1.51
5L1-20-00-SS3A3	3.5	1	36.7	1361	1.83
5M1-20-00-SS-3A4	4.0	1	42.0	1430	2.10
5N1-20-00-SS-3A4	4.5	1	47.2	1505	2.35
6L1-20-00-SS-4A3	3.5	1	36.7	1501	1.83
6M1-20-00-SS-4A4	4.0	1	42.0	1576	2.10
6N1-20-00-SS-4A4	4.5	1	47.2	1651	2.36
8O1-20-00-SS-6A6	5.563	1	58.3	2290	2.92
8P1-20-00-SS-6A6	6.625	1	69.4	2420	3.47

## Fintube Specific Data

MODEL	NO. FINS	TUBE O.D Inches	NO. U-Tubes	SURFACE Ft <sup>2</sup>	WEIGHT LBS.	Ft. <sup>2</sup> SURFACE PER FOOT
2B1-20-00-16SS-1A¾	16	0.75	1	72	306	3.73
2D1-20-00-16SS-1A¾	16	1.0	1	65	382	3.38
2F1-20-00-24SS-1A1	24	1.315	1	51	380	2.69
2.5D1-20-00-16SS-1½A¾	16	1.0	1	68	402	3.52
2.5F1-20-00-24SS-1½A1	24	1.315	1	89	497	4.69
2.5G1-20-00-24SS-1½A1	24	1.66	1	64	498	3.31
2.5G1-20-00-32SS-1½A1	32	1.66	1	80	524	4.20
2.5H1-20-00-24SS-1½A1	24	1.9	1	60	511	2.99
2.5H1-20-00-36SS-1½A1½	36	1.9	1	80	700	3.99
3H1-20-00-24SS-2A1½	24	1.9	1	96	615	5.00
3H1-20-00-36SS-2A½	36	1.9	1	141	657	7.10
3J1-20-00-24SS-2A2	24	2.375	1	63	625	3.24
3J1-20-00-40SS-2A2	40	2.375	1	88	648	4.58
3.5H1-20-00-24SS-2A1½	24	1.9	1	136	833	7.00
3.5H1-20-00-36SS-2A1½	36	1.9	1	202	895	10.10
3.5J1-20-00-24SS-2A2	24	2.375	1	102	834	5.22
3.5J1-20-00-40SS-2A2	40	2.375	1	154	876	7.91
4H1-20-00-24SS-3A1½	24	1.9	1	174	943	9.00
4H1-20-00-36SS-3A1½	36	1.9	1	262	1025	13.10
4J1-20-00-24SS-3A2	24	2.375	1	141	944	7.24
4J1-20-00-40SS-3A2	40	2.375	1	218	975	11.24
4K1-20-00-24SS-3A2½	24	2.875	1	108	1008	5.51
4K1-20-00-40SS-3A2½	40	2.875	1	159	1072	8.17
5L1-20-00-24SS-3A3	24	3.5	1	138	1093	6.88
5L1-20-00-40SS-3A3	40	3.5	1	203	1145	10.17
5L1-20-00-56SS-3A3	56	3.5	1	316	1197	15.83
6N1-20-00-24SS-4A4	24	4.5	1	146	1231	7.40
6N1-20-00-48SS-4A4	48	4.5	1	241	1309	12.30
6N1-20-00-64SS-4A4	64	4.5	1	306	1361	15.70

# MULTI-TUBE HAIRPIN SECTIONS

## BARE TUBE SPECIFIC DATA

MODEL	TUBE O.D. Inches	NO. U- TUBES	SURFACE FT <sup>2</sup>	WEIGHT LBS.	FT <sup>2</sup> SURFACE PER FOOT
2A4-20-00-SS-1A1	.625	4	26.8	403	1.31
2B2-20-00-SS-1A1	.75	2	16.0	323	0.79
2.5A7-20-00-SS-1½A1½	.625	7	46.8	553	2.30
2.5B4-20-00-SS-1½A1½	.75	4	32.0	513	1.57
3A7-20-00-SS-2A2	.625	7	47.0	627	2.29
3B7-20-00-SS-2A2	.75	7	56.4	662	2.75
3D3-20-00-SS-2A2	1.0	3	32.3	549	1.57
3.5A12-20-00-SS-2A2	.625	12	80.76	916	3.93
3.5B7-20-00-SS-2A2	.75	7	56.60	851	2.75
3.5C7-20-00-SS-2A2	.84/.875	7	66.0	883	3.21
3.5D4-20-00-SS-2A2	1.0	4	43.1	779	2.10
4A19-20-00-SS-3A3	.625	19	128.0	1127	6.22
4B12-20-00-SS-3A3	.75	12	96.9	1046	4.71
4B7-20-00-SS-3A2	.75	7	56.5	920	2.75
4C7-20-00-SS-3A3	.84/.875	7	66.0	953	3.21
4D7-20-00-SS-3A3	1.0	7	75.4	1015	3.67
5A31-20-00-SS-3A3	.625	31	210.0	1674	10.14
5B19-20-00-SS-3A3	.75	19	154.7	1488	7.46
5B12-20-00-SS-3A3	.75	12	97.7	1396	4.71
5D9-20-00-SS-3A3	1.0	9	97.8	1413	4.71
6A42-20-00-SS-4A4	.625	42	285.5	2192	13.75
6B24-20-00-SS-4A4	.75	24	195.9	1900	9.42
6B31-20-00-SS-4A4	.75	31	252.3	2098	12.17
6D14-20-00-SS-4A4	1.0	14	152.0	1775	7.33
8A85-20-00-SS-6A6	.625	85	583.3	3814	27.81
8B55-20-00-SS-6A6	.75	55	453.0	3404	21.59
8B44-20-00-SS-6A6	.75	44	362.4	3092	17.27
8C37-20-00-SS-6A6	.84/.875	37	354.5	2817	16.95
8D31-20-00-SS-6A6	1.0	31	340.3	3076	16.23
8D24-20-00-SS-6A6	1.0	24	264.5	2797	12.57
10A121-20-00-SS-6A6	.625	121	832	5443	39.59
10B85-20-00-SS-6A6	.75	85	700.79	5074	33.37
10D42-20-00-SS-6A6	1.0	42	462.8	4424	21.99
12A174-20-00-SS-8A8	.625	174	1192.6	7516	56.93
12B121-20-00-SS-8A8	.75	121	994	6863	47.50
12D64-20-00-SS-8A8	1.0	64	704.2	6115	33.51
16A301-20-00-SS-12A12	.625	301	2059.7	11870	98.49
16B199-20-00-SS-12A12	.75	199	1636.5	11256	78.13
16D109-20-00-SS-12A12	1.0	109	1189	9466	57.07

## FINTUBE SPECIFIC DATA

MODEL	NO. FINS	TUBE O.D. Inches	NO. U- Tubes	SURFACE Ft <sup>2</sup>	WEIGHT LBS.	FT <sup>2</sup> SURFACE PER FOOT
3B3-20-00-16SS-2A1½	16	0.75	3	121.53	700	6.18
4B7-20-00-16SS-3A2	16	0.75	7	236	1260	12.08
4C7-20-00-16SS-3A3	16	.84/.875	7	216.6	1283	11.05
5D7-20-00-16SS-3A3	16	1.0	7	298.4	1292	15.33
5D7-20-00-24SS-3A3	24	1.0	7	448	1840	23.13
6B14-20-00-16SS-4A4	16	0.75	14	471	2205	24.16
6D10-20-00-16SS-4A4	16	1.0	10	365	2040	18.57
6D10-20-00-24SS-4A4	24	1.0	10	493	2440	25.24
8B19-20-00-16SS-6A4	16	0.75	31	1042	3050	53.51
8B31-20-00-16SS-6A4	16	0.75	19	956	2650	49.01
8C19-20-00-16SS-6A4	16	.84/.875	19	787	2810	40.37
8D19-20-00-16SS-6A4	16	1.0	19	691	2930	35.28
8D19-20-00-24SS-6A4	24	1.0	19	933	3310	47.95
10B42-20-00-16SS-6A6	16	.75	42	1466	4743	72.49
10D31-20-00-24SS-6A6	24	1.0	31	1581	4932	78.24
12B64-20-00-16SS-8A8	16	.75	64	2236	6561	110.46
12D44-20-00-24SS-8A8	24	1.0	44	2245	6643	111.05
16B109-20-00-16SS-12A12	16	.75	109	3803	10954	188.13
16D77-20-00-24SS-12A12	24	1.0	77	3927	10522	194.34

# R.W HOLLAND OFFERS FLEXIBILITY TO MEET CUSTOMER APPLICATIONS AND SPECIFICATIONS

## TUBE END CLOSURES

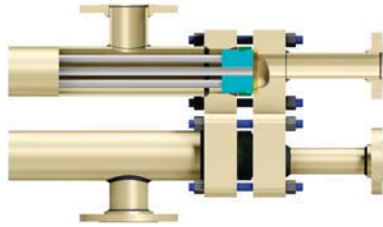

Holland standard closure. Tube nozzles can be offset for venting and draining. ANSI flange connections.

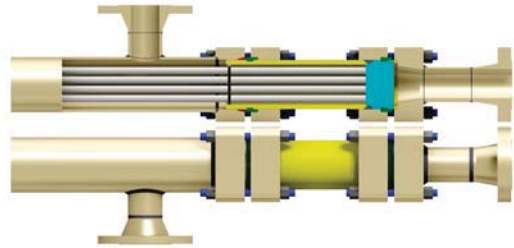

Holland separated head closure. Separate flanges and bolting for each gasket surface.

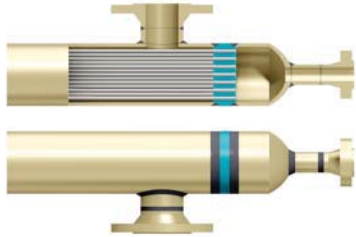

Fixed tubesheet design, non-removable channel.

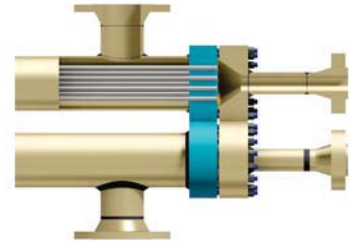

Fixed tubesheet design with removable channel for tube inspection.

## RETURN END CLOSURES

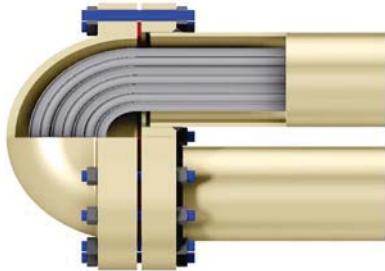

Holland standard closure. When casting is removed, tube returns are completely exposed.

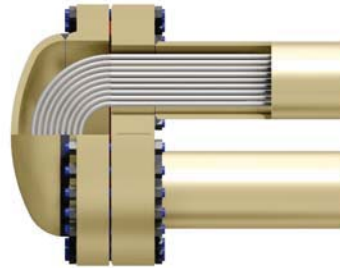

Fabricated closure for high pressure and alloy design where standard closure is not adequate.

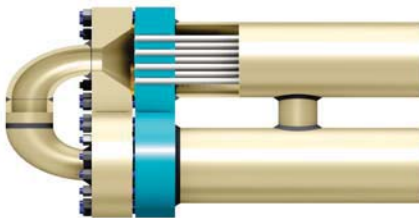

Rod thru design with fixed tubesheets allows straight thru cleaning of tubes. Expansion joints furnished when required.

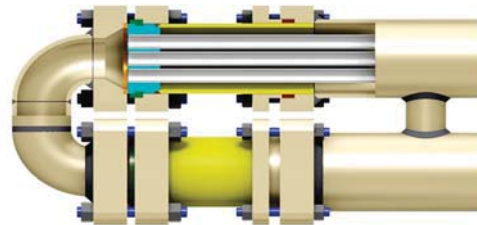

Rod thru design with packed joint which allows straight thru cleaning of tubes and removing bundle.



Welded closure for all welded design units using elliptical or hemispherical heads.



Welded closure for all welded design using a 180 degree return.

# R. W. HOLLAND, INC.

PETROFIN® Hairpin Heat Exchangers

*Serving the petroleum, petrochemical, chemical and power industries.*

Bulletin 10

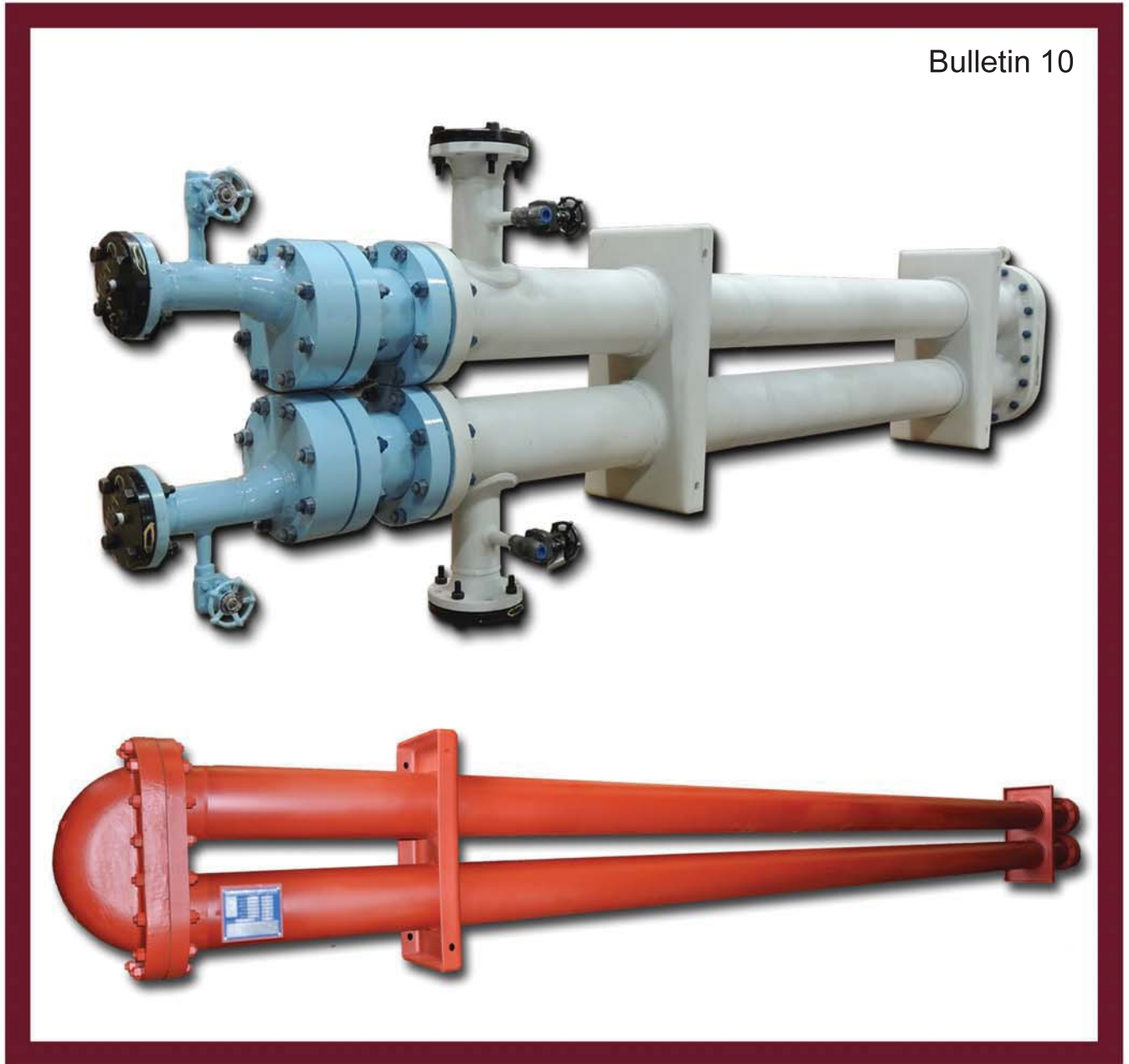

Email: [sales@rwholland.com](mailto:sales@rwholland.com) Web Site: [www.rwholland.com](http://www.rwholland.com)  
P.O. Box 472336 Tulsa, Oklahoma 74147-2336 918-664-7822  
5004 South 101st East Avenue Tulsa, Oklahoma 74146-4919 Fax: 918-665-1605